

DPFHP451 HIGH PERFORMANCE BILEVEL STEP MOTOR / MANUAL PRESET INDEXER DRIVER PACK

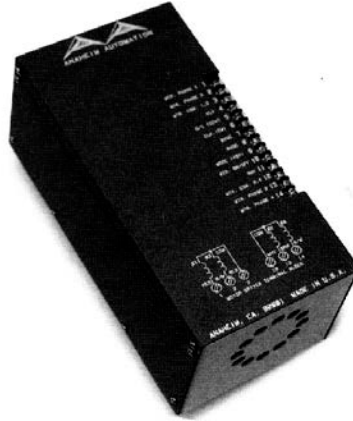

- Internal Index Count switches
- Pulse Rates up to 14,792 pulses per second
- CW & CCW Home, Hard, & Soft Limit Inputs
- Adjustable Motion "Complete" Output
- Motion "Busy" Output
- Clock Pulses and Step Direction Outputs
- CW and CCW Index Inputs
- CW and CCW Jog/Run and Fast Jog Inputs
- Two "Go to Home Position" modes
- TTL-MOS Compatible
- Pulse & Reset Outputs & Coincidence Inputs
- Very High Motor Power Output
- 15Amps/phase Maximum Operating Current
- 10 Amps/phase Standstill motor current
- Dual Voltage Power Supply with 500VA Transformer
- High Start-Stop Speeds
- Transient Voltage Suppression
- Halfstep and Fullstep Operation
- Bilevel Drive (No RFI or EMI problems)
- TTL/CMOS Compatible Inputs
- Clock and Direction or Dual Clock Operation
- Motor Turn-off Input

GENERAL DESCRIPTION

The Anaheim Automation DPFHP451 Step Motor Driver Pack is designed for motor applications that require very high power output and high start-stop step rates. Outstanding motor performance is achieved by means of an enhanced bilevel or dual-voltage drive technique. This Driver Pack contains a high performance driver board (BLHP101), a 500VA transformer, and a dual power supply. It may be used with six or eight lead, size 34 and 42 step motors whose phase current ratings range from 2 to 12.5 amperes per phase.

BILEVEL DRIVE

The basic function of a step motor driver is to control the motor winding currents. Motor performance is determined by how fast the driver can increase and decrease the winding currents. A rapid rise in winding current is achieved by applying a high voltage directly to a motor. This rapid rise of current is also referred to as the "kick" or operating current. When a desired current level is reached, a low voltage is applied to maintain a suitable holding current level. When a motor winding is turned off, a rapid decrease in winding current is achieved by routing the energy in the

collapsing field back to the power supply through a high voltage path. The high voltage supply furnishes the energy necessary to maintain motor output torque at high step rates thus providing high mechanical power output. The low voltage supply provides much of the current needed at low step rates and all of the holding current.

Bilevel drivers do not use high frequency switching techniques as chopper drivers do. Consequently, they do not create the EMI, RFI, and motor heating problems that are associated with chopper drivers.



ANAHEIM AUTOMATION, INC.

4985 East Landon Drive, Anaheim, CA 92807
sales@anaheimautomation.com

P: (714) 992-6990 F: (714) 992-0471
www.anaheimautomation.com

TRANSIENT VOLTAGE SUPPRESSION

Transient Voltage Suppression (TVS) Diodes on the motor phase outputs allow for much longer motor cables to be used. Normally when using long motor cables, voltage transients and spikes are created. These transients often exceed the voltage ratings of the output phase transistors, resulting in blown transistors. The addition of the TVS Diodes suppresses these transients and protects the transistors against damage.

MOTOR ON/OFF INPUT

The MOTOR ON/OFF input can be used to turn off all four motor phases (de-energize the motor) in applications where motor detent torque is sufficient to maintain the load position. This feature can be used to reduce the load on the power supply and the heat dissipation in the driver circuitry and motor. Terminal 10 is the MOTOR ON/OFF Input.

MODE SELECT/+5V OUTPUT

DPFHP001 Driver Packs are shipped from the factory with terminal 9 assigned as an excitation Mode Select input. The Mode Select input is used to select either halfstep or fullstep motor operation. Halfstep operation is generally preferred because this mode provides better resolution, minimizes resonance effects, and reduces power consumption. The motor steps in increments of half the natural step angle, e.g. in 0.9 degree steps for a 1.8 degree step motor. In fullstep operation, the motor steps in 1.8 degree steps. By setting JP2 to the "1-2" position, terminal 9 becomes a +5VDC regulated output. The driver defaults to halfstep when the +5VDC output is used.

ADJUSTING THE KICK CURRENT

The kick (or operating) current level is the desired phase current level that the high voltage provides each time a step is taken. The high voltage is turned off when this level is reached. The kick current level should be set to approximately 1.4 times the rated phase current. For example, a motor rated at 10 amps/phase should be "kicked" to 14 amps. Table 2 shows various kick current levels for corresponding phase currents. When using a motor listed in Table 3, use

the recommended potentiometer setting. **WARNING:** The kick current level must be set before operating a motor.

MOTOR DRIVER CONNECTIONS

Motor wires are connected to the driver pack through terminals 1, 2, 3, 12, 13, and 14. Electrical connections to control inputs should be kept physically separated from the motor connections. Wiring from the driver to the motor should be routed away from all other wiring.

OTHER HIGH PERFORMANCE DRIVER PACKS

are available. The DPFHP451 Driver Pack includes a PI45 Preset Indexer along with the bilevel high performance driver and power supply. The DPFHP401 includes a SMC40 based Programmable Indexer. All DPFHP Series Driver Packs are available in 250 VAC versions (add "X250" suffix).

MOUNTING AND COOLING

The DPFHP451 contains an internal fan to create airflow through the unit. Heating considerations should include where the unit is mounted, the duty cycle of operation, ambient temperature, etc. Care should be taken so that no point on the chassis exceeds 60 degrees Celsius.

Rated Motor Phase Current	KICK CURRENT
1.4 - 2.4	2.0 - 3.4
2.4 - 3.3	3.4 - 4.6
3.3 - 4.3	4.6 - 6.0
4.3 - 5.4	6.0 - 7.5
5.4 - 6.3	7.5 - 8.8
6.3 - 7.2	8.8 - 10.1
7.2 - 8.1	10.1 - 11.4
8.1 - 8.9	11.4 - 12.5
8.9 - 9.6	12.5 - 13.5
9.6 - 12.5	13.5 - 15.0

Table 1: Potentiometer Settings for Kick Current

AA MOTOR	HOLDING CURRENT	KICK CURRENT
34D106	1.95 - 3.00	4.20
34D109	3.12 - 4.80	6.72
34D207	2.28 - 3.50	4.90
34D209	3.00 - 4.60	6.44
34D213	4.23 - 6.50	9.10
34D307	2.28 - 3.50	4.90
34D311	3.58 - 5.50	7.70
34D314	4.55 - 7.00	9.80
42D112	3.97 - 6.10	8.54
42D119	6.18 - 9.50	13.3
42D212	3.97 - 6.10	8.54
42D219	5.98 - 9.20	12.88
42D225	8.25 - 10.00	15.00

TABLE 2 Holding Current and Kick Current Settings for AA Motors

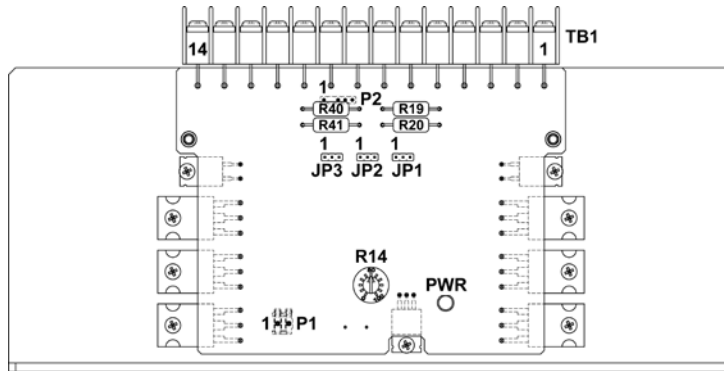

JUMPER DESCRIPTION	JP1	JP2	JP3
TERMINAL 5 = DIRECTION	2-3	X	X
TERMINAL 5 = CCW	1-2	X	X
TERMINAL 9 = HS/FS	X	2-3	X
TERMINAL 9 = +5VDC OUTPUT	X	1-2	X
POSITIVE GOING CLOCK INPUTS	X	X	2-3
NEGATIVE GOING CLOCK INPUTS	X	X	1-2
STANDARD PRODUCT (READY TO SHIP)	2-3	2-3	1-2

TORQUE/SPEED CURVES

34D106 and 34D109

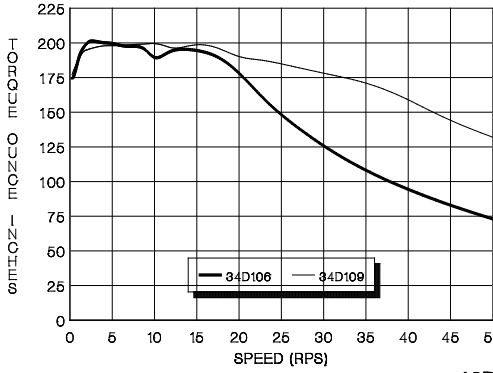

34D207, 34D209, 34D213

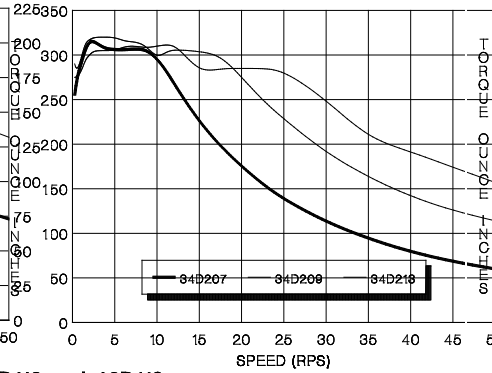

34D307, 34D311, 34D314

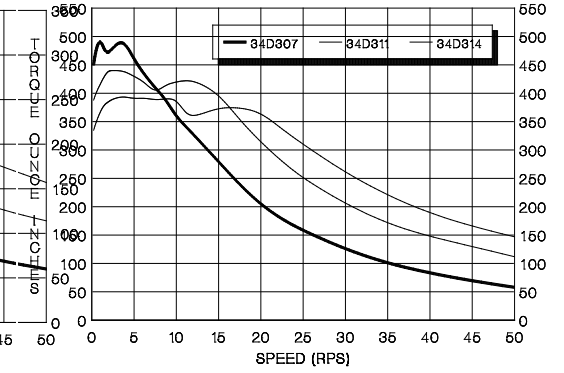

42D112 and 42D119

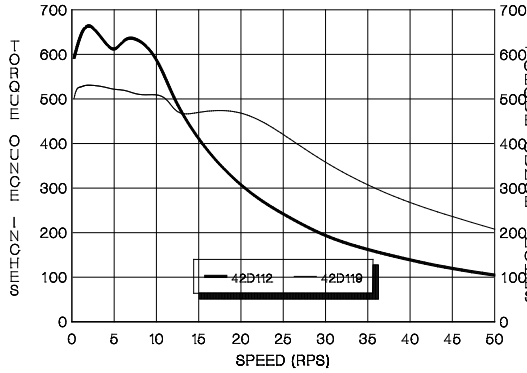

42D212, 42D219, 42D225

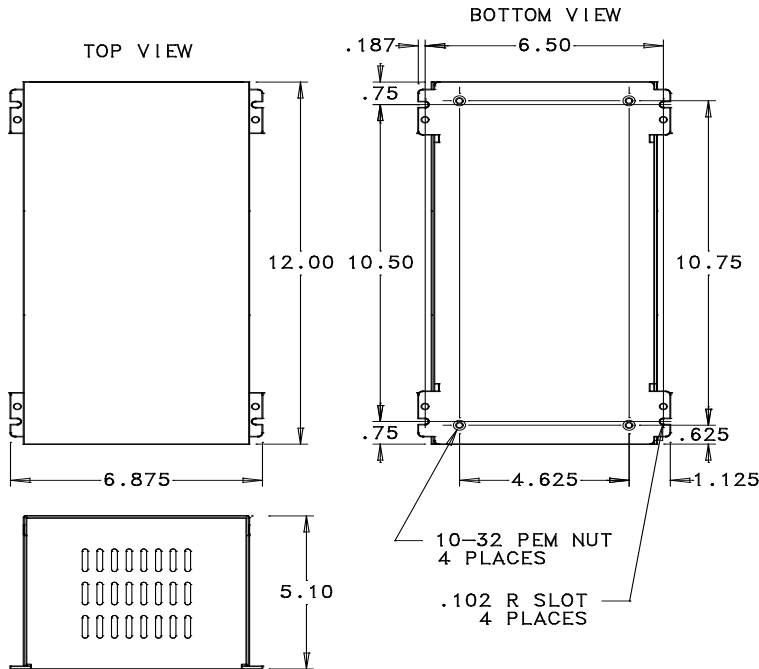
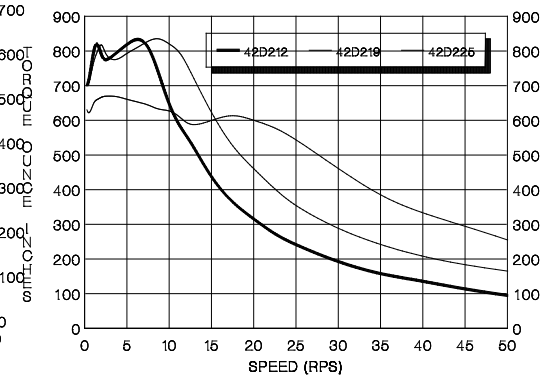

INDEXER DESCRIPTION AND FUNCTION

MANUAL PRESET INDEXER BOARD

The Manual Preset Indexer board utilizes the PI45 Preset Indexer integrated circuit (I.C.). Functions available are Home, Hard and Soft Limit inputs, two Homing modes, Jog/Run, Fast Jog and switch selectable Base Speed, Maximum Speed, Acceleration/Deceleration.

This board includes the necessary buffering and other circuitry for the PI45 chip that makes indexing easy. The board can be operated manually or with a Programmable Logic Controller (PLC) to index a set of pulses determined by the internal count switches or an external count module, such as the AA1760-5 or similar device.

MANUAL PRESET INDEXER TERMINAL (P1) DESCRIPTION

<u>PIN</u>	<u>FUNCTION</u>	<u>DESCRIPTION</u>
1	-HARD LIMIT	When active low, this signal instructs the step motor to halt all motion in CCW direction.
2	+HARD LIMIT	Same as -HARD LIMIT except in CW direction.
3	-SOFT LIMIT	When active low, this signal instructs the step motor to ramp down to base speed and complete the move. Input active during a -Index or -Home function.
4	+SOFT LIMIT	Same as -SOFT LIMIT except in CW direction.
5	-HOME LIMIT	Used in H0 Homing mode in conjunction with -Soft Limit. Giving -Home command (active low) causes motor to ramp to high speed in the CCW direction until -Soft Limit is contacted. At contact, motor will decelerate to base speed and run until the -Home Limit is contacted, at which time the motor will stop.
6	+HOME LIMIT	Same as -HOME LIMIT except in CW direction.
7	-JOG/RUN	A low level on this line causes the step motor to take one step in the CCW direction. Normally, the JOG/RUN inputs are manipulated by external pushbutton switches. A single depression of the switch causes a "jog" operation, while holding the switch down for 0.5 seconds causes a "slow run" condition. This command may be used with FAST to perform a fast run at the base speed rate.
8	+JOG/RUN	Same as -JOG/RUN except in CW direction.
9	-HOME	A low level on this line instructs the step motor to move to the home position via the CCW direction. (See HOME SELECT)
10	+HOME	Same as -HOME except in CW direction.
11	-INDEX	When low, this signal causes the PI45 chip to read the current motion parameters and number of steps from the thumbwheel switches and command the motor to step the indicated distance in the CCW direction. (See -SOFT LIMIT). NOTE : If -SOFT LIMIT is encountered during an Index, the motor will decelerate to base speed and complete the Index.
12	+INDEX	Same as -INDEX, but commands a CW step motion.
13	#INT/EXT	This input determines which set of switches will be used for counting. A logic "1" or open selects the Internal Index Count Number. A logic "0" selects the count of an external counter module.
14	HOME SELECT	This input selects the type of "Home" operation to perform: When active low, H0 Homing Mode is selected. It is a standard deceleration and stop on switch operation. In essence, type H0 is a combination of the HOME and SOFT limit commands. When active high, H1 Homing Mode is selected. H1 is used for anti-backlash protection. It performs a decelerate, reverse, return off switch operation. NOTE: the switch must remain closed during deceleration, reverse, and return in H1 Mode.

- 15 FAST When active low, it is used in conjunction with JOG/RUN to cause a fast run (base speed) operation in the specified direction.
- 16 BUSY This open collector switch output is ON when the motor is moving. This output can sink 0.5A and stand off 40Vdc maximum. A 10k ohm pullup resistor can be jumpered in place to provide TTL levels (see section on Jumpers).
- 17 CLOCK This output is an open collector output, 15 microseconds wide (minimum) that is the clock input for the motor driver. It is buffered to assure adequate drive for an LS-TTL input. This signal is internally connected to the driver.
- 18 0VDC Ground (0Vdc).
- 19 DIRECTION Clockwise (CW) motion causes this output to be active high i.e. logic "1". Counterclockwise motion causes this output to be active low i.e. logic "0". This output tells the motor driver which direction to run. This signal is internally connected to the driver.
- 20 COMPLETE This open collector switch output turns on after the indexing cycle is executed. The pulse width (time that this output is on) is adjustable from about 12ms to 120ms (see Table 3). This output can sink 0.5A and stand off 40Vdc maximum. A 10k ohm pullup resistor can be jumpered in place to provide TTL levels. (see section on Jumpers).

SETTING	PULSE WIDTH	SETTING	PULSE WIDTH
1	12 ms	6	79.5 ms
2	25.5 ms	7	93 ms
3	39 ms	8	106.5 ms
4	52.5 ms	9	120 ms
5	66 ms	--	--

TABLE 3: Pulse Width Settings

TYPICAL HOOK-UPS FOR BUSY AND COMPLETE OUTPUTS:

K1 will energize immediately after completion of an index cycle and remain energized for approximately an amount of time set by the "COMPLETE PULSE WIDTH" POT. K2 will be energized throughout an index cycle.

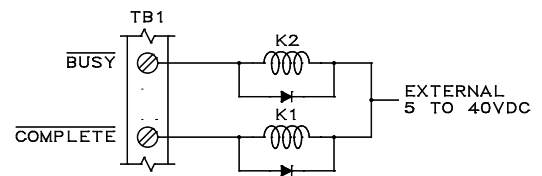

MANUAL PRESET INDEXER TERMINAL (P2) DESCRIPTION

PIN	FUNCTION	DESCRIPTION
1	+5VDC	+5VDC Regulated Voltage Supply Output
2	+12VDC Unreg	+12VDC Unregulated Voltage Supply Output
3	0VDC	Ground (0Vdc).
4	0VDC	Ground (0Vdc).
5	9 - 12VAC IN	9 - 12VAC Voltage Supply Input for PCL451 version.
6	9 - 12VAC IN	9 - 12VAC Voltage Supply Input for PCL451 version.

USING THE MANUAL PRESET INDEXER

SELECTING MOTION PARAMETERS

The velocity profile (motion speed and acceleration) is determined by the four green switches; the Base Speed, Max Speed, Acceleration/Deceleration, and Factor. Figure 5 shows a typical velocity profile of a step motor.

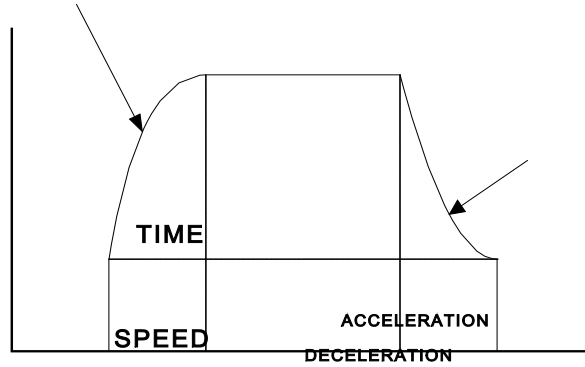

BASE SPEED

This is the speed at which the motor starts to run. There are 256 choices of Base Speeds as shown in the Table 6. They range from 2 steps/second to 3,611 steps/second.

MAX SPEED

As shown in Table 5, there are 256 choices available ranging from 163 steps/second to 14792 steps/second.

ACCELERATION/DECELERATION

The step motor starts to accelerate after taking 4 steps at the base speed and continues until it reaches the selected maximum speed taking the number of steps set by A/D at each speed in the internally generated ramp table. A/D=0 is no acceleration (run at BASE speed only), A/D=1 is the fastest (minimum ramp time), and A/D=F is the slowest (maximum ramp time). The step motor starts to decelerate at the calculated point and continues until it reaches the selected base speed and stops.

FACTOR

The F switch should be set first because it directly affects the Base and Max speed. Table 4 lists the maximum obtainable stepping rates for all F switch settings with the maximum speed F.

F	Max(steps/sec)	F	Max	F	Max	F	Max
0	14792	4	4930	8	2548	C	728
1	9264	5	4266	9	1816	D	484
2	7165	6	3759	A	1411	E	366
3	5841	7	3360	B	946	F	246

TABLE 4: Maximum Rates for Factor Settings

EXAMPLE

Assume that the motor is to run at a Max Speed of 4500 steps/second. It can be seen from the table above that this speed can only be obtained with the F switch setting of 0 through 4. Any of these switch settings could provide speeds in excess of 4500 steps/second. The 'rule of thumb' is to always choose the highest F switch setting that will provide the desired Max Speed, and also give the widest range for Base Speeds. In this example, F with a switch setting of 4 is the best choice. For a desired speed of 1200 steps/second, set F switch to A. For a desired speed of 13000 steps/second, only an F switch setting of 0 will suffice.

SETTING THE M SWITCH

Now that we have selected the F switch setting, we can find the value for M from Table 5. The factor setting is in the left hand column, and the Max Speed setting is along the top row. In example 1 for the desired M of 4500 steps/second, we set the F switch at 4. Table 4 lists the maximum speed values for each switch setting of F. Looking at the M values in Table 5 for an F switch setting of 4, the closest speeds are 4495 (M=C) and 4631 (M = D). For the desired maximum speed of 1200 steps/second (F=A) and M switch setting of 9 (1173 sps) or A (1207 sps) can be used. A speed of 13000 sps (F=0) requires an M switch setting of either A (12737 sps) or B (13102 sps).

M SWITCH SETTING

	0	1	2	3	4	5	6	7	8	9	A	B	C	D	E	F
F	163	166	170	174	179	183	188	193	199	204	210	217	223	231	238	246
E	242	248	253	259	266	272	279	287	295	303	313	322	332	342	354	366
D	320	327	335	342	351	360	369	380	390	401	412	425	438	452	467	484
C	481	493	504	517	529	543	557	572	588	604	623	641	661	682	705	728
B	626	641	656	672	689	706	725	744	764	786	809	833	859	886	915	946
A	936	957	980	1004	1028	1054	1082	1111	1141	1173	1207	1242	1281	1322	1365	1411
9	1207	1234	1263	1293	1325	1358	1394	1431	1470	1511	1544	1601	1650	1702	1757	1816
8	1699	1737	1777	1820	1864	1911	1959	2011	2066	2123	2184	2248	2316	2388	2466	2548
7	2248	2298	2351	2407	2466	2526	2591	2658	2730	2805	2884	2968	3057	3152	3252	3360
6	2520	2576	2635	2697	2762	2830	2902	2977	3057	3141	3229	3323	3422	3527	3640	3759
5	2866	2930	2997	3067	3141	3218	3299	3384	3474	3568	3669	3774	3886	4005	4132	4266
4	3322	3397	3474	3554	3639	3728	3821	3919	4022	4132	4246	4367	4495	4631	4777	4930
3	3953	4040	4131	4227	4326	4431	4540	4655	4777	4904	5039	5181	5332	5491	5661	5841
2	4878	4985	5095	5211	5332	5459	5592	5732	5879	6033	6196	6368	6551	6743	6948	7165
1	6369	6504	6646	6793	6948	7110	7279	7456	7642	7838	8045	8263	8492	8734	8991	9264
0	9968	10190	10422	10664	10918	11185	11464	11758	12067	12393	12737	13102	13487	13895	14330	14792

TABLE 5: Max Speed (Factor Setting vs. Max Setting)

SETTING THE B SWITCH

By choosing an F value, we restrict our choice of Base Speed to 16 possible values (see Table 6). In example 1, from maximum speed of 4500 steps/second (F = 4) we can select Base speeds ranging from 42 to 1223 steps/second. For the desired maximum speed of 1200 sps (F=A), the Base speed can be chosen from a range of 11 sps to 339 sps. If due to the selection of the factor we are limited to a low Base Speed, it is possible to choose a lower Factor and then choose the appropriate Base and Max settings. Thus, for maximum speed of 1200 sps, a Factor of 9 could also be used, giving the range of Base Speed 15 to 438 sps.

B SWITCH SETTING

	0	1	2	3	4	5	6	7	8	9	A	B	C	D	E	F
F	2	5	10	15	19	24	27	32	37	40	44	47	50	53	56	59
E	3	7	14	22	29	36	41	48	54	60	65	71	75	79	83	87
D	4	10	19	28	38	48	54	64	72	79	86	93	99	105	110	115
C	6	14	29	43	57	72	81	97	109	120	130	141	150	159	166	174
B	8	19	37	56	75	94	106	126	141	157	170	183	195	207	216	227
A	11	28	56	84	112	140	159	189	212	234	254	274	292	309	324	339
9	15	37	73	109	145	181	205	244	274	303	329	355	377	399	418	438
8	21	52	103	154	205	256	290	349	387	428	464	501	533	564	590	619
7	28	69	138	206	273	341	386	459	515	569	618	666	707	749	784	821
6	31	78	155	231	307	383	434	516	578	640	694	748	795	841	880	922
5	35	89	177	264	350	438	495	589	659	730	791	853	906	959	1003	1052
4	42	104	206	308	408	510	577	686	768	849	921	993	1054	1116	1167	1223
3	50	124	247	370	489	610	690	821	919	1015	1101	1187	1260	1333	1394	1460
2	62	154	309	460	610	761	860	1021	1143	1264	1368	1474	1565	1655	1730	1812
1	83	206	411	612	809	1009	1141	1352	1513	1671	1809	1947	2066	2181	2281	2389
0	124	310	617	919	1216	1519	1717	2038	2282	2520	2730	2939	3120	2957	3448	3611

TABLE 6: Base Speed (Factor Setting vs. Base Setting)

HOMING MODES

There are two Homing Modes that may be initiated, H0 and H1.

H0 HOMING MODE

This mode causes the motor to run at Max Speed in the direction selected. The motor runs until the nut encounters the SOFT limit switch, at which time the motor decelerates to the Base Speed. The nut continues to run at Base Speed until it hits the Home limit switch. This may be illustrated by using a step motor driving a leadscrew as shown below. CAUTION: The two limit switches should be placed such that the nut after hitting the Soft limit switch has enough time to get to Base Speed before encountering the Home limit switch.

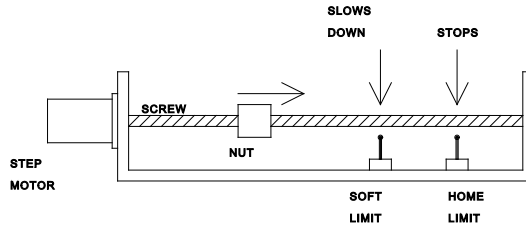

H1 HOMING MODE

When this homing mode is selected, the nut seeks home at Max speed. It decelerates to Base speed when the soft limit switch is encountered. The Soft limit switch must remain closed until the motor completely decelerates to Base speed, at which time the controller causes the motor to reverse direction and run at Base speed until the Soft limit switch is no longer closed. This mode is illustrated below. This Homing mode uses only one switch, but a flag is required to keep the switch closed during the deceleration cycle. If only a momentary switch closure is made, the motor will decelerate to Base speed and stop. This stopping point may not be accurate or repeatable; so, the flag is necessary.

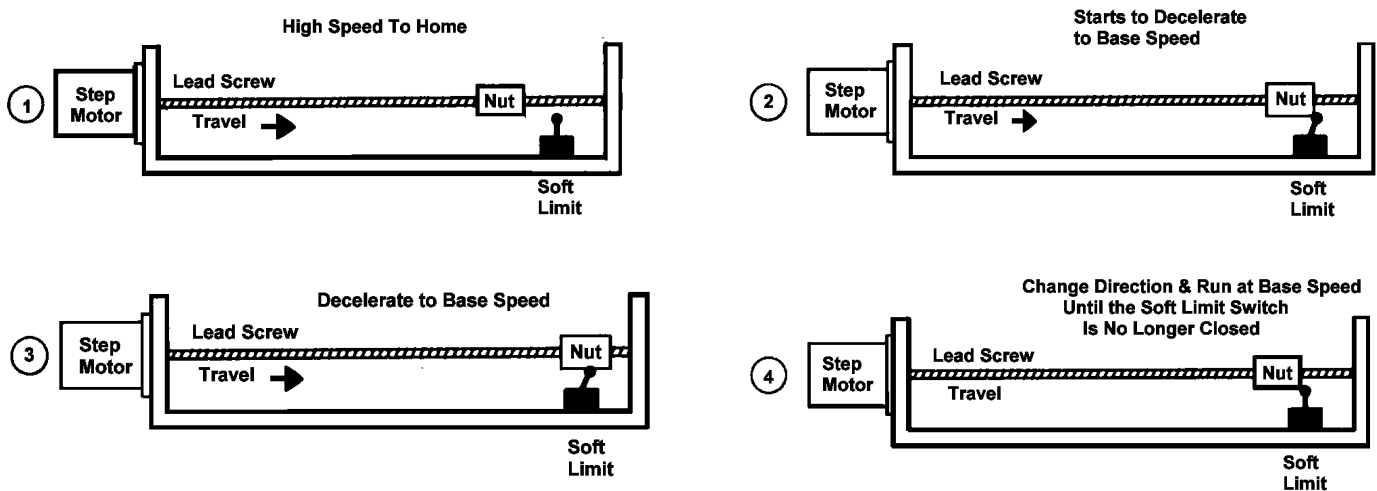

Figure 7: H1 Homing Mode

SETTING THE MOVE DISTANCE

The index count or move distance for the DPFHP451 can be accomplished by a number of methods. The easiest way is to use the red switches labeled "Internal Index Number" on the unit; these switches are used by default. External Count Modules may also be used. These include the Click Pot Module, AA1748, the Thumbwheel Module, AA1760, the BCD Input Module, AA2210, and the Quad Board, AA1754. These modules set the distance of the move, but will allow for different variations in interfacing (see descriptions in next section).

JUMPERS

There are four jumpers on the Manual Preset Indexer board. The first jumper, JP1, is used to set the debounce delay time for the JOG, HOME, and INDEX inputs. When JP1 is in the "1-2" position, the debounce delay is approximately 12.5 milliseconds. When JP1 is in the "2-3" position, the debounce delay is approximately 0.3 milliseconds. The active low signal on these inputs must be wider than the debounce delay time.

To use an external Count Module, the INT/EXT input (pin 13) must be pulled low to a logic "0". The on-board switches will be ignored. External Count Modules plug into either connector labeled "EXTERNAL COUNT MODULE CONNECTOR"(P1 or P2). When only using one module for both FORWARD and REVERSE indexes, jumper JP2 must be in the "1-2" position.

When using external Count Modules, it is possible to use one module for FORWARD indexing and another module for REVERSE indexing. The connector on the side of the unit is the FORWARD count; the connector on the top (of front face) is the REVERSE count. When using two modules for different FORWARD and REVERSE indexes, jumper JP2 must be in the "2-3" position.

JUMPER LOCATIONS / FUNCTIONS

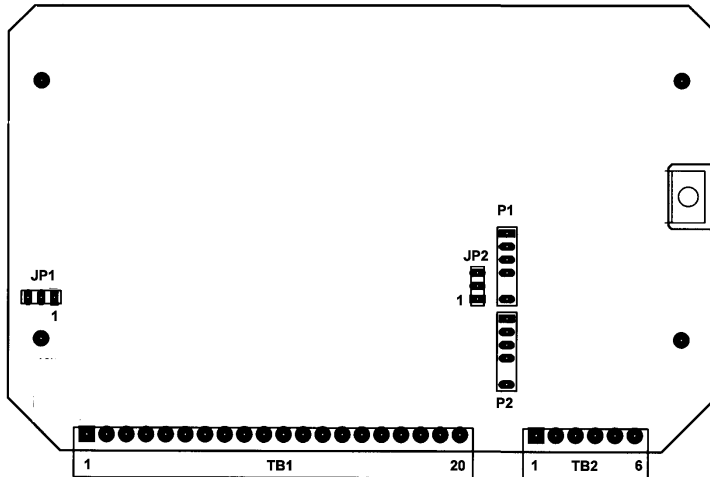

JP1	DEBOUNCE INPUT DELAY
1-2	12.5 ms
2-3	0.3 ms

TABLE 7

JP2	EXTERNAL COUNT MODULES
1-2	ONE MODULE (SAME FORWARD AND REVERSE)
2-3	SEPARATE MODULES FOR FORWARD AND REVERSE

TABLE 8

COUNT INPUT BOARDS

All of the Count Input Boards or Modules set the number of steps the motor will move when an Index is initiated, but each Module allows for a different variation in interfacing.

AA1748 - CLICK POT MODULE

A 'CLICK POT' module consists of 10 position (0 - 9) digital pots mounted on a printed circuit board. One pot is used per each decade (digit). These units are available in 2, 4, or 6 decades. The user dials in the step count on the pots. Any time the motor is indexed, it will move the number of steps set on the pots. One module is required per axis. The module is connected to the Manual Preset Indexer via a supplied 5 lead cable.

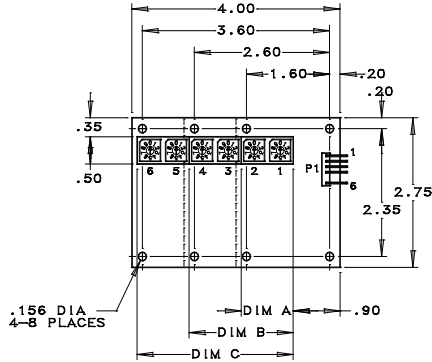

PANEL CUTOUT DIMENSIONS

MODEL NO.	DIM A	DIM B	DIM C
AA1748-2	1.00	X	X
AA1748-4	X	2.00	X
AA1748-6	X	X	3.00

MAX. PCB LENGTH

AA1748-2	2.00
AA1748-4	3.00
AA1748-6	4.00

NOTE:
IF UNIT IS TO BE MOUNTED TO THE BACK SIDE OF A PANEL WITH A CUTOUT FOR SWITCH ACCESS, USE MINIMUM .375" SPACER FROM FRONT SIDE OF PCB.

AA1760 - THUMBWHEEL SWITCH MODULE

These thumbwheel switches provide an attractive way to input a step count. The user dials in the desired count on the thumbwheels, which can be mounted on an enclosure face. The module is available in 3, 4, 5, or 6 decades. The module is connected via a supplied 5-lead cable.

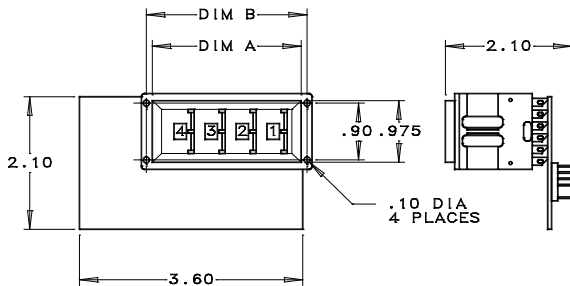

PANEL CUTOUT DIMENSIONS

MODEL NO.	DIM A	DIM B
AA1760-2	1.42	1.59
AA1760-3	1.92	2.09
AA1760-4	2.42	2.59
AA1760-5	2.92	3.09
AA1760-6	3.42	3.59

AA1754 - QUAD BOARD COUNTER

The quad board module is a 4-bank version of the clickpot module with each bank having 6 decades. The user can "dial in" four different move lengths and then select any one of them as desired. The module is connected to the indexer via a supplied 5-lead cable.

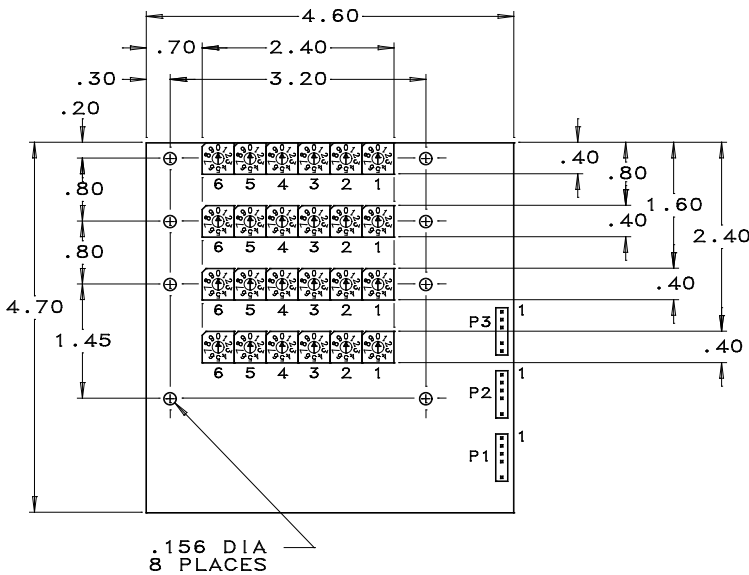

CONNECTOR	Pin 1	Pin 2	Pin 3	Pin 4	Pin 5	Pin 6
P1 (To Indexer)	Common	+5Vdc	Clock	Reset	Key	0Vdc
P2 (Expansion)	Common	+5Vdc	Clock	Reset	Key	0Vdc
P3 (Select Inputs)	Select #1	Select #2	Select #4	Key	+5Vdc	0Vdc

TABLE 9

The selection of the switch banks is done by switching select lines 1 and 2 on connector P3. The select lines are "low true" meaning that if a select line is pulled low (to 0Vdc), it is recognized as being "on" or "true". When a select line is not pulled low it is internally "pulled up" to +5Vdc and is "off" or "false". The bank select lines must be set at least 1 millisecond before the Index command is given. The select lines must remain in the set state until the index is complete. Once the move is finished, the select lines may be changed as needed.

BANK SELECT TABLE	SELECT LINE	
	#1	#2
SWITCH BANK #1	0	0
SWITCH BANK #2	1	0
SWITCH BANK #3	0	1
SWITCH BANK #4	1	1

0 = Low 0 - .8Vdc 1 = High 3.5 - 5Vdc

TABLE 10

Select line #4 is only used if additional count input devices are "daisychained" to the expansion connector (P2). If select line #4 is low, that quad board is ignored and the count input device connected to the P2 expansion connector is read. This allows multiple quad boards to be used together. The "daisychained" count input device does not have to be a quad board; it could be a thumbwheel switch or click pot module.

AA2210 BCD COUNTER MODULE

The AA2210 BCD counter interface module enables the user to select any move length from 0 to 999,999 steps using a standard PLC (programmable logic controller). Selecting the proper inputs creates a count value in steps, resulting in a move distance. The module is connected to the indexer via a supplied 5-lead cable.

Note: All Inputs are active low (0-0.8Vdc). All unused inputs may be ignored since they are pulled up.

Example: For a move distance of 1234 steps the following inputs should be pulled low.

1's Decade: Bit 4 (TB1, pin 4)

10's Decade: Bit 1 and 2 (TB2, pin 2 and 3)

100's Decade: Bit 2 (TB1, pin 7)

1000's Decade: Bit 1 (TB2, pin 6)

All Other inputs must be open or high (3.5-5Vdc).

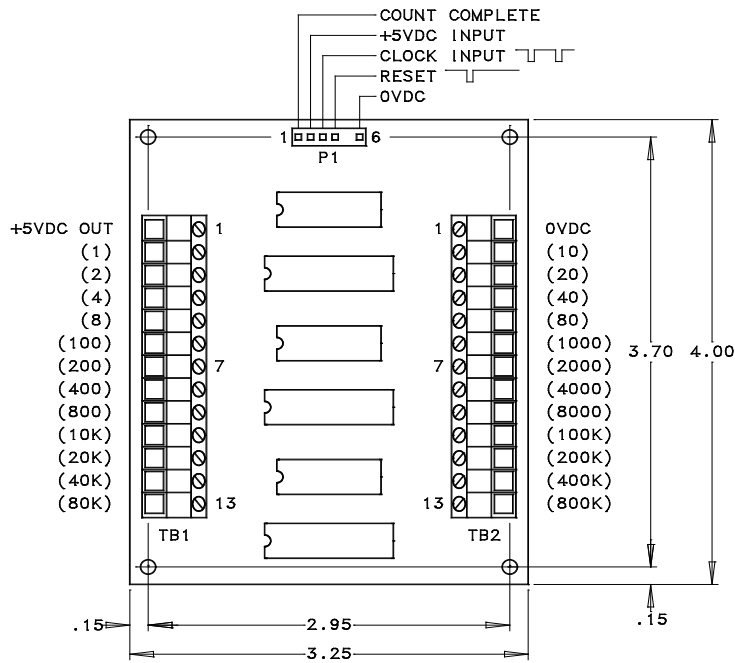

SPECIFICATIONS

CONTROLLER INPUTS: TTL-MOS Compatible
Logic "0": 0 to 0.8 Vdc
Logic "1": 3.5 to 5 Vdc

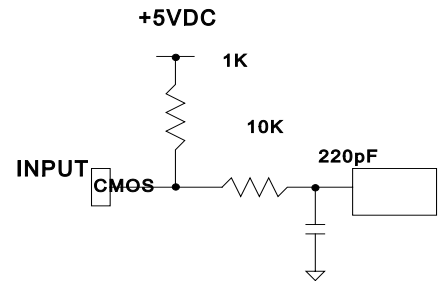

All Input Terminals are pulled up to +5Vdc through 1k ohm resistors.

Busy and Complete Outputs (pins 16 and 20) are open collector outputs that can sink 500mA and stand-off 40Vdc maximum (no sourcing). Pull-up resistors may be jumpered to these outputs to produce TTL level signals (see section on jumpers).

Ground (pin 18) - 0Vdc

+5Vdc Output (TB2, pin 1) - Up to 250mA is available for the user to power up external circuitry. The total current drawn from pin 1 and pin 2 must not exceed 250mA.

+12Vdc Unregulated Output (TB2, pin 2) - Up to 250mA is available for the user to power up external circuitry. The total current drawn from pin 1 and pin 2 must not exceed 1.0A.

DRIVER INPUTS: Terminals 5,6,9,10
Logic "0": 0 to 0.8 VDC.
Logic "1": 3.5 to 5 VDC.

POWER REQUIREMENT

105 VAC to 125 VAC for DPFHP451

210 VAC to 250 VAC for DPFHP451x250

MODE SELECT

When programmed as Mode Select Input (set by JP2), this terminal is internally pulled up to +5VDC through a 10k ohm resistor. When a logic "1" (or no connection) is applied, the motor will operate in halfstep mode. When a logic "0" is applied, the motor will operate in fullstep mode.

MOTOR ON/OFF INPUT

This terminal is internally pulled up to +5VDC through a 10k ohm resistor. When a logic "1" (or no connection) is applied, the driver phase outputs are enabled and the motor is energized. When a logic "0" is applied, the driver phase outputs are disabled and the motor is de-energized.

MOTOR PHASE OUTPUTS: (Terminals 1,2,13,14)

These outputs can sink a peak of 15 Amperes or sink 10 Amperes continuously and stand-off 250 VDC maximum.

MOTOR COMMON OUTPUTS: (Terminals 3,12)

These outputs can source a peak current of 15 Amperes, or source 10 Amperes continuously.

AMBIENT TEMPERATURE: 0 to 50 degrees Celsius.



**4985 E. Landon Drive
ANAHEIM, CA 92807
Tel: 714.992.6990 Fax: 714.992.0471
Email: info@anaheimautomation.com**