

MLA10641 High Performance Microstepping Driver

User's Guide



ANAHEIM AUTOMATION

4985 E. Landon Drive Anaheim, CA 92807
e-mail: info@anaheimautomation.com

(714) 992-6990 fax: (714) 992-0471
website: www.anaheimautomation.com

MLA10641 High Performance Microstepping Driver Features

- Size 5.50”L x 2.96”W x 5.54”H
- High Torque Output
- Output Current 10.0 Amps Peak
- 200 to 12,800 steps/rev (1, 2, 5, 8, 10, 16, 32 and 64 selectable step operations)
- Short Circuit Protection
- Over-Temperature and Over-Voltage Shutdown
- No Minimum Inductance
- Optical Isolation
- Motor ON/OFF Input

Introduction

The MLA10641 high-performance microstepping driver has an output current capability from 2.0 Amps minimum to 10.0 Amps maximum (Peak Rating). The MLA10641 driver operates with an AC voltage of 90-132 Volts. The inputs are optically isolated with a minimum sourcing of 7.0 mA per input (+5VDC minimum to +24VDC maximum). The clock input is set to receive either positive or negative edge clocks with a maximum frequency of 400KHz. The MLA10641 driver offers direction control and motor current ON/OFF capabilities. The Reduce Current Enabled function automatically reduces motor current to 50% of set value after the last step is made. The driver has built-in features to indicate power on (Green LED), Clocks being received (Yellow LED) and fault conditions (Red LED).

With the MLA10641, various step resolutions can be implemented by the onboard DIP switch. These divisions range from 200 steps per revolution to 12,800 steps per revolution. The bipolar drive configuration handles 4, 6 and 8 lead motors. Protection devices have been added to this driver for Phase to Phase Short-Circuit, Motor Mis-Wire, Over Temperature and Over-Voltage conditions.

Pin Descriptions

The Inputs on the MLA10641 are optically isolated with the anode (+) and cathode (-) both brought out to the user. With no current going through the opto-diode, the input is considered high. To enable the input a minimum of 7.0 mA needs to be sourced or sunk through the opto-diode. This is done simply by placing a voltage range of +5 to +24VDC across the two inputs of the opto-diode. If sinking current, then all three anodes (+) should be tied together to the +voltage as shown in Figure 2. If sourcing current into the inputs, all three cathodes (-) should be tied together and grounded as shown in Figure 3. The MLA10641 also has an optically isolated Fault Output Signal. This output has an open collector maximum voltage of 30V and can sink up to 50mA.

Optically Isolated Inputs and Output

The following inputs and output to the MLA10641 are Optically Isolated.

Item	Pin #
Clock	1 & 2
Direction	3 & 4
On/Off	5 & 6
Fault Out	7 & 8

Table 1: Optically Isolated Pinout

To enable an input, apply a DC voltage source of +5VDC to +24VDC across the inputs. The Anodes (+) are pins 1, 3 and 5 and the Cathodes (-) are pins 2, 4 and 6.

TB1: 8 Pin Input Terminal Description

Pin #	Description
1	Step Clock Input Anode (+): A positive going edge on this isolated input advances the motor by one increment. The size of the increment is dependent on the Microstep Select Inputs of Switch 1.
2	Step Clock Input Cathode (-)
3	Direction Anode (+): This isolated input is used to change the direction of the motor. Physical direction also depends on the connection of the motor windings.
4	Direction Cathode (-)
5	ON/OFF Anode (+): This isolated input is used to enable and disable the output section of the driver. When HIGH (open), the outputs are enabled. However, this input does not inhibit the step clock.
6	ON/OFF Cathode (-)
7	Fault Out (C): This is the collector of the optically isolated fault output. When NO fault occurs, this output will conduct current into the emitter. Care must be taken to not pass more than 50mA of current through this transistor.
8	Fault Out (E): This is the emitter of optically isolated fault output.

Table 2: Pin descriptions for input terminal block connector (TB1)

TB2: 3 Pin AC IN Terminal Description

Pin #	Description
1	AC IN: Hot
2	AC IN: Neutral
3	EARTH GROUND (Must be connected)

Table 3: Pin descriptions for input terminal block connector (TB2)

TB3: 5 Pin Input Terminal Description

Pin #	Description
1	Motor Ground
2	Phase 1A: Phase 1 of the Step Motor
3	Phase 1B: Phase 3 of the Step Motor
4	Phase 2A: Phase 2 of the Step Motor
5	Phase 2B: Phase 4 of the Step Motor

Table 4: Pin descriptions for motor terminal block connector (TB3)

Power Supply Requirements

The MLA10641 has an input line voltage ranging from 90-132VAC. TB2 pin 1 is used as the hot terminal and is internally fused, TB2 pin 2 is used as the neutral terminal and TB2 pin 3 is the EGND terminal. The EGND terminal must be connected.

****NOTE: The 10EMC1 Filter is required at the power input of the MLA10641 driver.**

10EMC1 Filter



The 10EMC1 filter is required at the power input of the MLA05641 driver.

The 10EMC1 filter is designed to remove EMI-RFI (noise) from the power line, such as common and differential mode noises.

A filter is usually located in a system right where the power meets the unit or driver, so that EMI/RFI does not affect the unit or be emitted from the power source, such as a cord.

The 10EMC1 filter helps prevent damages to the system.

Specifications

Max. leakage current each Line to Ground:	Hipot rating (one minute):
@120 VAC 60 Hz: .21 mA	Line to Ground: 2250VDC
@250 VAC 50 Hz: .43mA	Line to Line: 1450VDC
Rated Voltage (max):	250 VAC
Operating Frequency:	50/60 Hz
Rated Current:	10 A
Operating Ambient Temperature Range (@ rated current I_R):	-10 °C to +40°C

Electrical Schematic

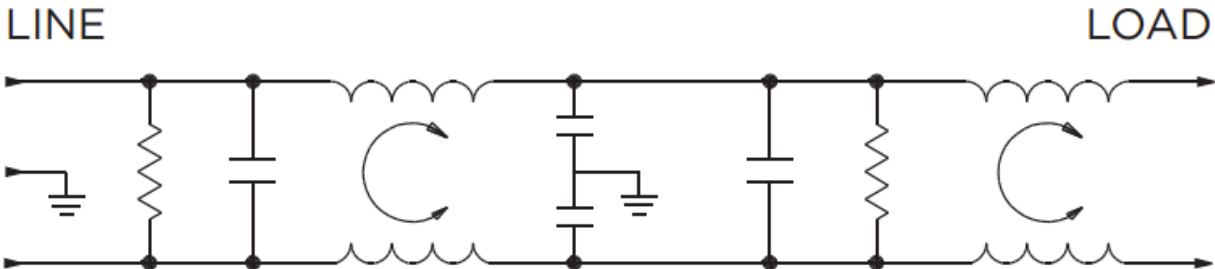

Dimensions

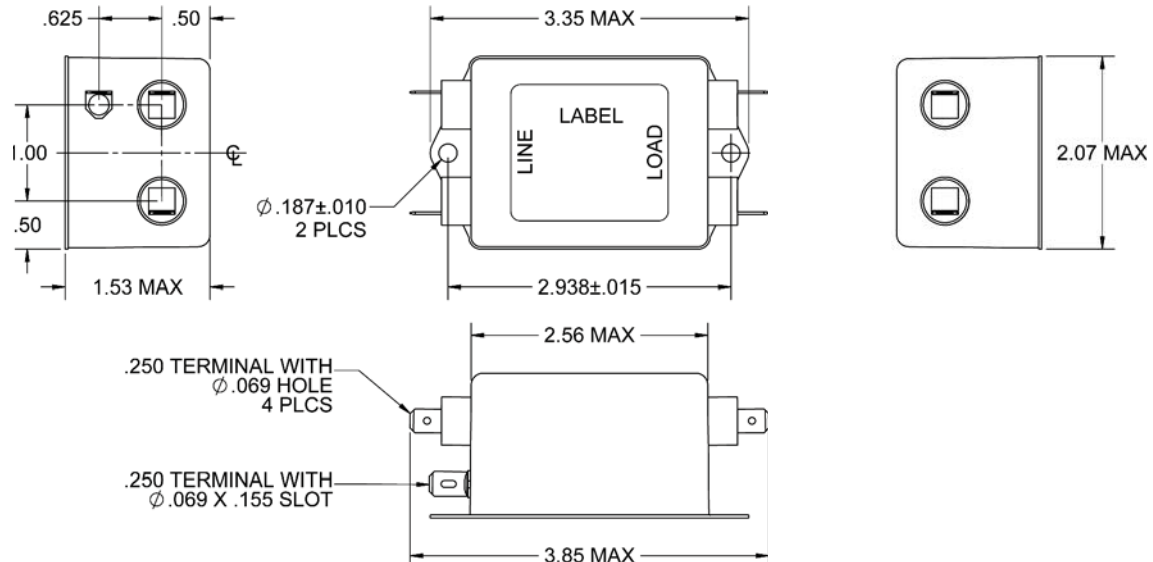

10EMC1 Filter Continued

Typical Insertion Loss

Measured in closed 50 Ohm System

10EMC

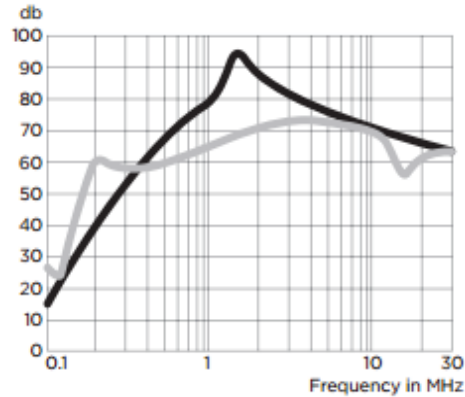

- Common Mode / Asymmetrical (L-G)
- Differential Mode / Symmetrical (L-L)

Minimum Insertion Loss

Common Mode/Assemetrical (Line to Ground)

Current Rating	Frequency - MHz								
	.05	.07	.11	.15	1	2	10	20	30
10A	5	2	13	24	72	72	56	50	48

Differential Mode/Symmetrical (Line to Line)

Current Rating	Frequency - MHz								
	.05	.07	.11	.15	1	2	10	20	30
10A	14	15	12	33	54	58	47	34	36

Ordering Information

Manufacturer	Part Number	Description
Mouser	592-10EMC1	Power Line Filters 10A 1/4"-1/4" FASTON FLANGE MOUNT
TE Connectivity / Corom	10EMC1	Power Line Filters 10A 1/4"-1/4" FASTON FLANGE MOUNT
Digi-Key	CCM1741-ND	FILTER LINE RFI COMPACT DUAL 10A
Mouser	644-DNF14-250FIB-3K	Terminals DISCO FEMALE FULLY- Insulated Disconnects
Panduit	DNF14-250FIB-3K	Terminals DISCO FEMALE FULLY-Insulated Disconnects
Ideal Industries	30-502	Crimpmaster™ Crimp Tool, for RG-58 RG-59/62AU BNC/TNC 3-Piece Hex Type Connectors

Absolute Maximum Ratings

Input Voltage: 132 VAC

Output Current: 10.0 AMPS PEAK

Max Plate Temperature: 70° C

Storage Temperature: 0° to +50°C

Input Voltage (For Isolated Inputs): +24V at 7mA

Fault Output Signal: Open Collector max. 30V/50mA (optically isolated)

Hi-Pot Rating (10 seconds): Line to Ground 1200VAC, 10mA

Electrical Specifications:

Item	Min	Typ	Max	Units
Input Voltage (Power)	90	115	132	VAC
Motor Bus Voltage	127	160	185	VDC
Phase Output Current	1.414		7.07	A (RMS)
Phase Output Current	2.0		10.0	A (PEAK)
Input Voltage (Inputs)	3.5		24	VDC
Clock Frequency	0		400	kHz
Chopping Frequency	28	30	32	kHz
Operation Temperature	0		70	C

Dimension Drawing

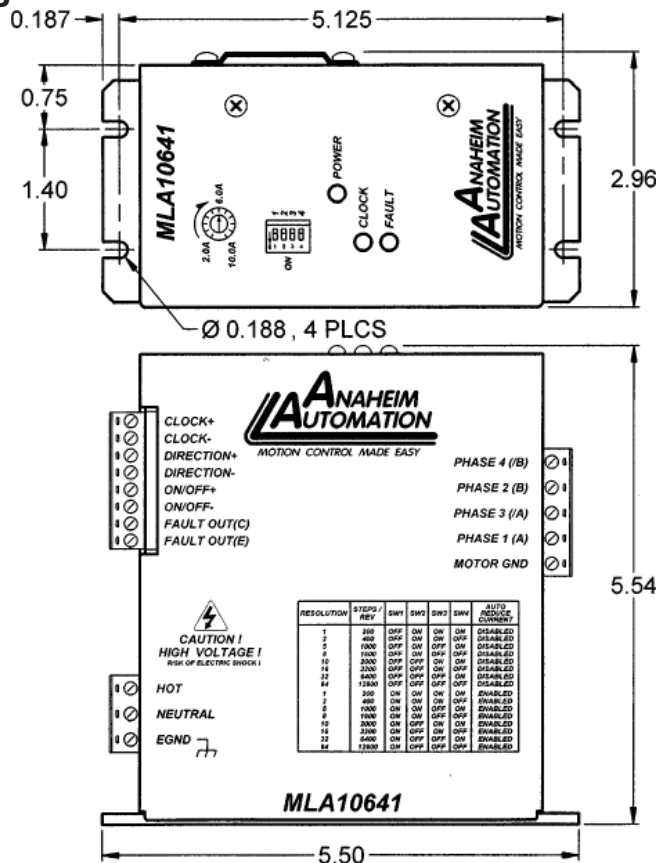

All units are in inches

Figure 1: MLA10641 Dimensions

Hook Up Drawings

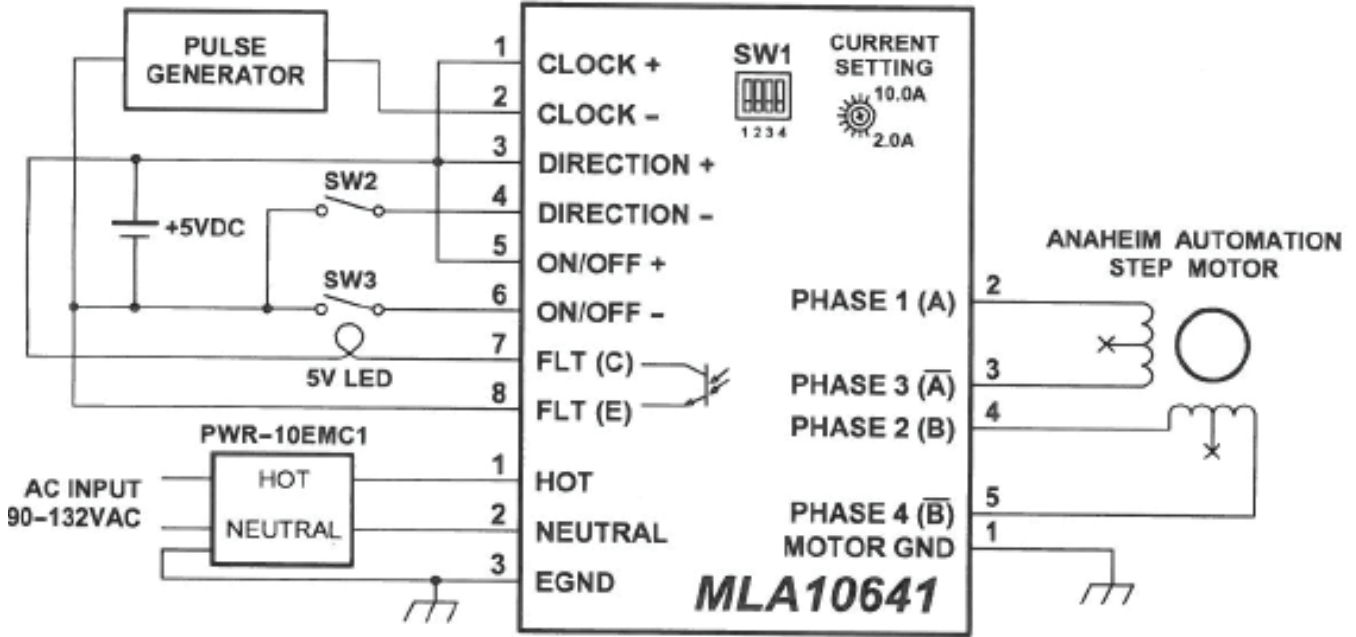

Figure 2: Hook up for current sinking inputs

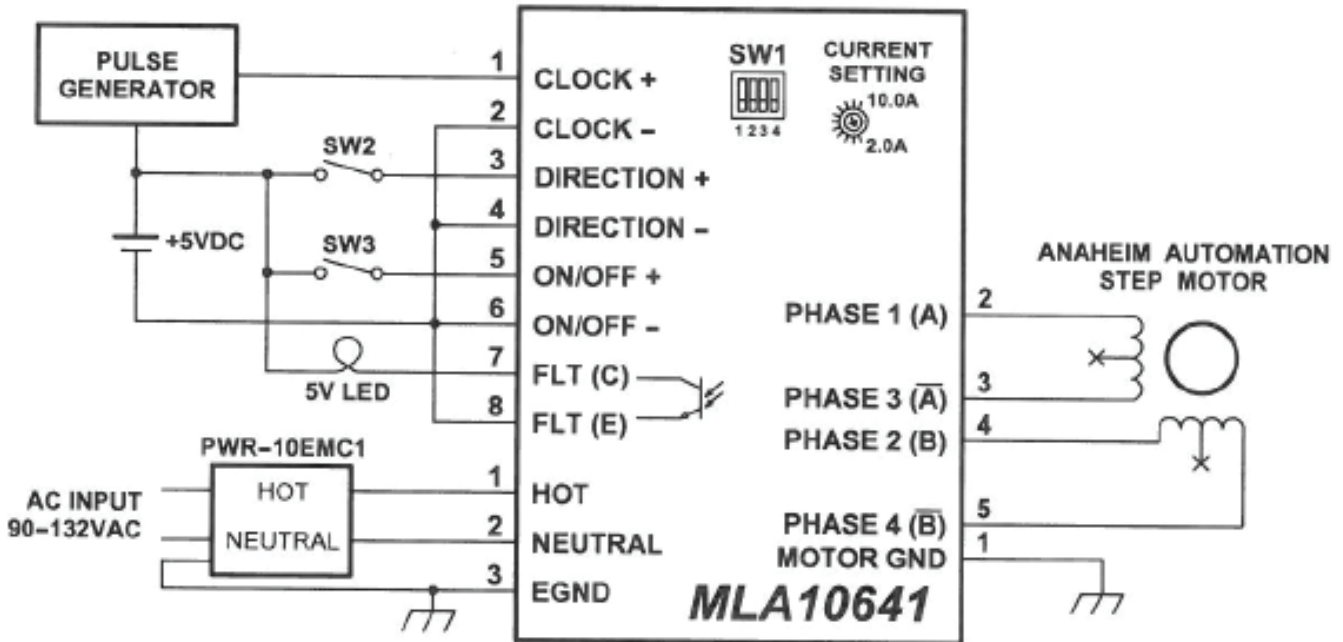

Figure 3: Hook up for current sourcing inputs

Motor Selection

The MLA10641 is a bipolar microstep driver that is compatible with both bipolar and unipolar motor configurations, (i.e. 8 and 4 lead motors, and 6 lead center-tapped motors).

Step motors with low current ratings and high inductance will perform better at low speeds, providing higher low-end torque. Motors with high current ratings and low inductance will perform better at higher speeds, providing more high-end torque. Higher voltages will cause the current to flow faster through the motor coils. This in turn means higher step rates can be achieved. *Care should be taken not to exceed the maximum voltage of the driver.*

Since the MLA10641 is a constant current source, it is not necessary to use a motor that is rated at the same voltage as the supply voltage. What is important is that the MLA10641 is set to the appropriate current level based on the motor being used. Refer to the following chart for setting the current potentiometer based on the current code in the part number of the motor. Examples of motor part numbers are shown below. Anaheim Automation offers a comprehensive line of step motors in various frame sizes. Contact the factory to verify motor compatibility with the MLA10641.

Step Motor Current Setting Guide

Motor Current Number Code	Unipolar Rating	Series Peak Rating	Parallel Peak Rating	Series Current Setting	Parallel Current Setting
02	1.0A	1.0A	2.0A	---	0%
03	1.5A	1.5A	3.0A	---	20%
04	2.0A	2.0A	4.0A	0%	30%
05	2.5A	2.5A	5.0A	12%	42%
06	3.0A	3.0A	6.0A	20%	52%
07	3.5A	3.5A	7.0A	25%	65%
08	4.0A	4.0A	8.0A	30%	75%
09	4.5A	4.5A	9.0A	36%	85%
10	5.0A	5.0A	10.0A	42%	100%
11	5.5A	5.5A	11.0A	47%	100%
12	6.0A	6.0A	12.0A	52%	100%
13	6.5A	6.5A	13.0A	60%	100%
14	7.0A	7.0A	14.0A	65%	100%
15	7.5A	7.5A	15.0A	70%	100%
16	8.0A	8.0A	16.0A	75%	100%
19	9.5A	9.5A	19.0A	90%	100%
22	11.0A	11.0A	22.0A	100%	100%
25	12.5A	12.5A	25.0A	100%	100%

Figure 6: Table selection for Anaheim Automation motor current settings

**Anaheim Automation offers motor cable, making hook-ups quick and easy!
Contact the factory or visit our website for more motor and cable offerings.**

Microstep Selection (DIP Settings)

Switches 2, 3 and 4, of the DIP switch select the microstep resolution of the driver. Table 7 shows the standard resolution values along with the associated positions for the select switches. The standard waveforms are sinusoidal. The steps/rev are based on a 200 step/rev motor.

Resolution	Steps/Rev	Position 1	Position 2	Position 3	Position 4	Auto Reduce Current
1	200	OFF	ON	ON	ON	Disabled
2	400	OFF	ON	ON	OFF	Disabled
5	1000	OFF	ON	OFF	ON	Disabled
8	1600	OFF	ON	OFF	OFF	Disabled
10	2000	OFF	OFF	ON	ON	Disabled
16	3200	OFF	OFF	ON	OFF	Disabled
32	6400	OFF	OFF	OFF	ON	Disabled
64	12800	OFF	OFF	OFF	OFF	Disabled
1	200	ON	ON	ON	ON	Enabled
2	400	ON	ON	ON	OFF	Enabled
5	1000	ON	ON	OFF	ON	Enabled
8	1600	ON	ON	OFF	OFF	Enabled
10	2000	ON	OFF	ON	ON	Enabled
16	3200	ON	OFF	ON	OFF	Enabled
32	6400	ON	OFF	OFF	ON	Enabled
64	12800	ON	OFF	OFF	OFF	Enabled

Table 7: Microstep selection on switch 1

Setting the Output Current

The output current on the MLA10641 is set by an onboard potentiometer. This potentiometer determines the per phase peak output current of the driver. The relationship between the output current and the potentiometer value is as follows:

Peak Current	Potentiometer Setting	Peak Current	Potentiometer Setting
2.00A	0%	6.80A	60%
2.30A	10%	7.50A	70%
3.00A	20%	8.40A**	80%
4.00A	30%	9.50A**	90%
4.80A	40%	10.00A**	100%
5.75A	50%	----	----

Table 8: Potentiometer values with respect to the output current

Refer to Table 6 for specific motor current settings.

** Although the MLA10641 has an internal fan, current settings above 8.4Amps (80%) may require additional cooling.

Reducing Output Current

Reducing the output current is accomplished by setting switch 1 of the DIP switch to the ON position. This should occur approximately after the last positive going edge of the step clock input. The amount of current per phase in the reduction mode is approximately 50% of the set current.

Determining Output Current

The output current for the motor used when microstepping is determined differently from that of a full/half step unipolar driver. In the MLA10641, a sine/cosine output function is used in rotating the motor. The output current for a given motor is determined by the motor's current rating and wiring configuration. There is a current adjustment potentiometer used to set the output current of the MLA10641. This sets the peak output current of the sine/cosine waves. The specified motor current (which is the unipolar value) is multiplied by a factor of 1.0, 1.4, or 2.0 depending on the motor configuration (series, half-coil or parallel, respectively).

Step Motor Configurations

Step motors can be configured as 4, 6, or 8 leads. Each configuration requires a different current. Refer to the lead configurations and procedures to determine their output current.

Warning! Step motors will run hot even when configured correctly. Damage may occur to the motor if a higher than specified current is used. Most specified motor currents are maximum values. Care should be taken to not exceed these ratings.

6 Lead Motors

When configuring a 6 lead motor in a **half-coil configuration** (connected from one end of the coil to the center tap), multiply the specified per Phase (or unipolar) current rating by 1.4 to determine the current setting potentiometer value. This configuration will provide more torque at higher speeds when compared to the series configuration.

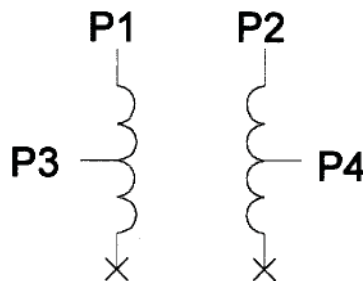

When configuring the motor in a **series configuration** (connected from end to end with the center tap floating) use the specified per Phase (or unipolar) current rating to determine the current setting potentiometer value.

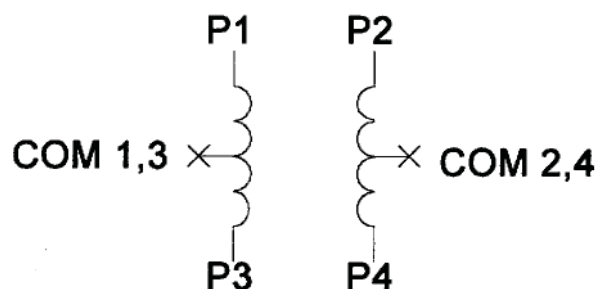

4 Lead Motors

Multiply the specified **series** motor current by 1.4 to determine the current adjustment potentiometer value. Four Lead Motors are usually rated with their appropriate series current, as opposed to the *Phase Current*, which is the rating for 6 and 8 lead motors.

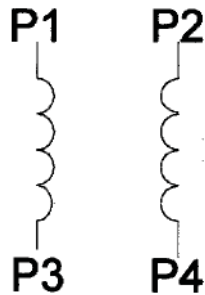

8 Lead Motors

Series Connection: When configuring the motor windings in series, use the per Phase (or unipolar) current rating to determine the current setting potentiometer value.

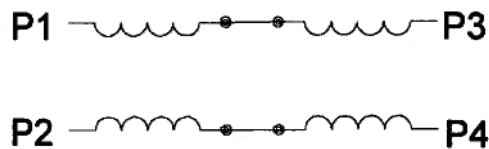

Parallel Connection: When configuring the motor windings in parallel, multiply the per Phase (or unipolar) current rating by 2.0 to determine the current setting potentiometer value.

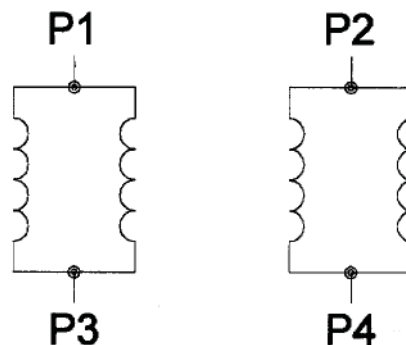

NOTE: After the current has been determined, according to the motor connection above, use Table 8 to choose the proper setting for the current setting potentiometer.

Connecting the Step Motor

Phase 1 and 3 of the step motor is connected between pins 1 and 2 on the motor connector (TB3). Phases 2 and 4 of the step motor are connected between pins 3 and 4 on the motor connector (TB3). The motor's case should be grounded to pin 5 on the motor connector (TB3) for protection. Refer to Figures 2 and 3 for TYPICAL APPLICATION HOOK-UP.

NOTE: The physical direction of the motor with respect to the direction input will depend on the connection of the motor windings. To reverse the direction of the motor with respect to the direction input, swap the wires on Phase 1 and Phase 3.

WARNING: Do not connect or disconnect motor wires while power is applied!

Short-Circuit, Mis-Wire, and Over-Current Conditions

If it is found that there is a condition that causes an over current in the driver phase transistors, the Red LED will turn on solid and power will be shut off to the motor. To reset the drive turn power off, check wiring, and turn power back on.

Over-Temperature and Over-Voltage Conditions

If it is found that there is an over temperature on the internal heat sink, or an over voltage on the motor bus voltage, the Red LED will blink and power will be shut off to the motor. To reset the drive turn power off, check wiring, and turn power back on.

Torque Speed Curves

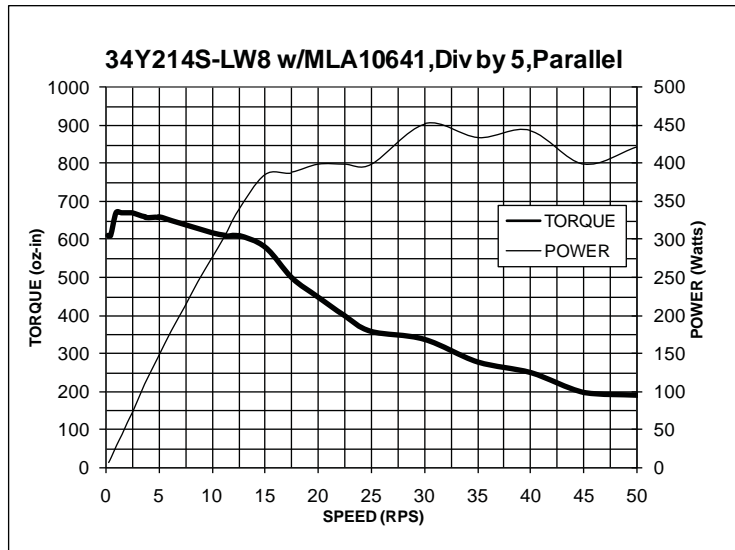
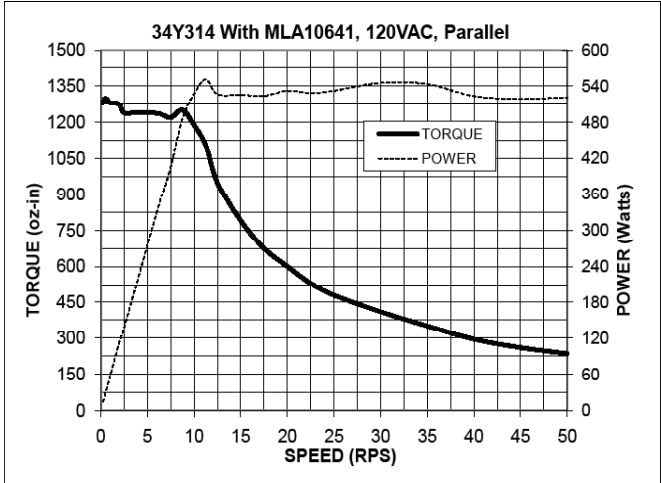
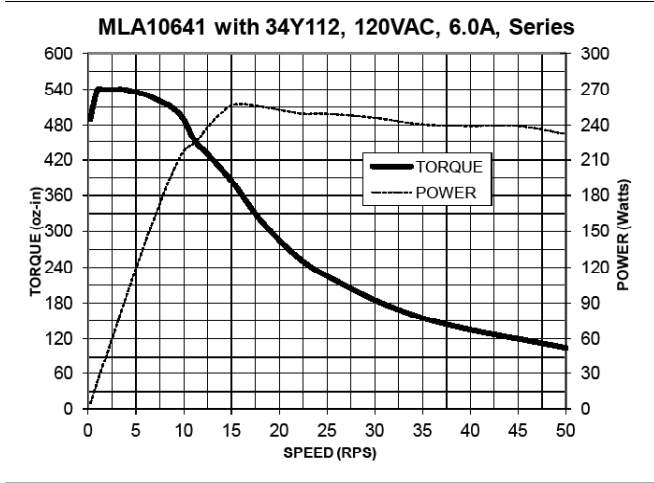

COPYRIGHT

Copyright 2007 by Anaheim Automation. All rights reserved. No part of this publication may be reproduced, transmitted, transcribed, stored in a retrieval system, or translated into any language, in any form or by any means, electronic, mechanical, magnetic, optical, chemical, manual, or otherwise, without the prior written permission of Anaheim Automation, 4985 E Landon Drive, Anaheim, CA 92807.

DISCLAIMER

Though every effort has been made to supply complete and accurate information in this manual, the contents are subject to change without notice or obligation to inform the buyer. **In no event will Anaheim Automation be liable for direct, indirect, special, incidental, or consequential damages arising out of the use or inability to use the product or documentation.**

Anaheim Automation's general policy does not recommend the use of its products in life support applications wherein a failure or malfunction of the product may directly threaten life or injury. Per Anaheim Automation's Terms and Conditions, the user of Anaheim Automation products in life support applications assumes all risks of such use and indemnifies Anaheim Automation against all damages.

LIMITED WARRANTY

All Anaheim Automation products are warranted against defects in workmanship, materials and construction, when used under Normal Operating Conditions and when used in accordance with specifications. This warranty shall be in effect for a period of twelve months from the date of purchase or eighteen months from the date of manufacture, whichever comes first. **Warranty provisions may be voided if products are subjected to physical modifications, damage, abuse, or misuse.**

Anaheim Automation will repair or replace at its' option, any product which has been found to be defective and is within the warranty period, provided that the item is shipped freight prepaid, with previous authorization (RMA#) to Anaheim Automation's plant in Anaheim, California.

TECHNICAL SUPPORT

If you should require technical support or if you have problems using any of the equipment covered by this manual, please read the manual completely to see if it will answer the questions you have. If you need assistance beyond what this manual can provide, contact your Local Distributor where you purchased the unit, or contact the factory direct.

ANAHEIM AUTOMATION